

Addressable Smoke Detector

User's Manual

V1.0.0

ZHEJIANG HUAXIAO TECHNOLOGY CO.,LTD.

Address: Area A, Floor 3, Building C, No.28 Dongqiao Road, Dongzhou Sub-district, Fuyang District, Hangzhou City, Zhejiang Province, China
 Website: www.wisualarm.com/en/home

Foreword

General

This manual introduces the functions and operations of the Addressable Smoke Detector (hereinafter referred to as "the Device").

Safety Instructions

The following categorized signal words with defined meaning might appear in the manual.

Signal Words	Meaning
DANGER	Indicates a high potential hazard which, if not avoided, will result in death or serious injury.
WARNING	Indicates a medium or low potential hazard which, if not avoided, could result in slight or moderate injury.
CAUTION	Indicates a potential risk which, if not avoided, could result in property damage, data loss, lower performance, or unpredictable result.
TIPS	Provides methods to help you solve a problem or save you time.
NOTE	Provides additional information as the emphasis and supplement to the text.

About the Manual

- The manual is for reference only. If there is inconsistency between the manual and the actual product, the actual product shall prevail.
- We are not liable for any loss caused by the operations that do not comply with the manual.
- The manual would be updated according to the latest laws and regulations of related jurisdictions. For detailed information, refer to the paper manual, CD-ROM, QR code or our official website. If there is inconsistency between paper manual and the electronic version, the electronic version shall prevail.
- All the designs and software are subject to change without prior

written notice. The product updates might cause some differences between the actual product and the manual. Please contact the customer service for the latest program and supplementary documentation.

- There still might be deviation in technical data, functions and operations description, or errors in print. If there is any doubt or dispute, we reserve the right of final explanation.
- Upgrade the reader software or try other mainstream reader software if the manual (in PDF format) cannot be opened.
- All trademarks, registered trademarks and the company names in the manual are the properties of their respective owners.
- Please visit our website, contact the supplier or customer service if there is any problem occurring when using the device.
- If there is any uncertainty or controversy, we reserve the right of final explanation.

Important Safeguards and Warnings

This section introduces content covering the proper handling of the device, hazard prevention, and prevention of property damage. Read carefully before using the device, comply with the guidelines when using it, and keep the manual safe for future reference.

Operation Requirements



- Make sure that the power supply of the device works properly before use.
- Transport, use and store the device under allowed humidity and temperature conditions.
- Prevent liquids from splashing or dripping on the device. Make sure that there are no objects filled with liquid on top of the device to avoid liquids flowing into it.
- Do not disassemble the device.

Installation Requirements



- Strictly abide by local electrical safety standards, and make sure that the voltage in the area is steady and conforms to the power requirements of the device.
- Do not connect the device to more than one power supply. Otherwise, the device might become damaged.



- Observe all safety procedures and wear required protective equipment provided for your use while working at heights.
- Do not expose the device to direct sunlight or heat sources.
- Do not install the device in humid, dusty or smoky places.
- Install the device in a well-ventilated place, and do not block the ventilator of the device.

Maintenance Requirements



- Use the accessories suggested by the manufacturer. Installation and maintenance must be performed by qualified professionals.
- Clean the device with a soft dry cloth or a clean soft cloth dipped in neutral detergent.
- Contact your local dealer or the service center nearest to you if the device needs internal configuration or maintenance. Do not dismantle or modify the device without a qualified professional present to avoid the risk of danger or damage to the device. We will assume no responsibility for any problems caused by unauthorized modifications or maintenance.

1 Product Information

1.1 Introduction

DHI-HY-1301 Addressable Smoke Detector is a mated product of the Addressable Fire Alarm Control Panel. Integrated with non-polarity two wire and smoke sensor, this detector analyzes ambient smoke concentration by intelligent algorithm to trigger alarms. When the concentration has reached the alarm threshold, the Addressable Fire Alarm Control Panel will confirm a fire alarm according to the received message sent from the detector, and the detector indicator will light

simultaneously to indicate alarm.

It is suitable for such industrial and civil buildings that have a great deal of smoke when fire takes place but no smoke under normal circumstances, such as hotels, teaching buildings, office buildings, computer rooms, communication machine rooms, libraries and archives. It is not suitable for places with a great deal of retained dust and water mist, places where steam and/or oil mist may be generated and places with retained smoke under normal circumstances.

1.2 Features

- Convenient wiring: Two-wire, polarity-free
- Reliable communication: Built-in microprocessor, stable performance
- Ultra-low power consumption: Ultra-low monitoring current and alarm current
- Detection performance: Accurate smoke detection by sensitive sensor

1.3 Dimension

Figure 1-1 Dimension [mm (inch)]

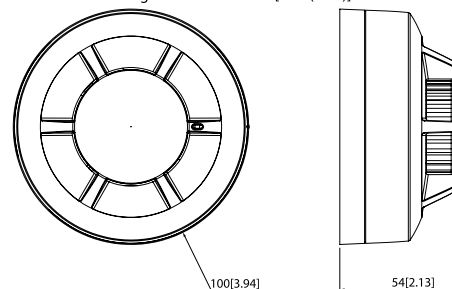

2 Technical Information

Parameter	Introduction
Electrical	
Working Voltage	24V DC
Current	Monitoring current: $\leq 180\mu\text{A}$ Maximum operating current: $\leq 280\mu\text{A}$
Indicator	Red LED <ul style="list-style-type: none"> Polling: Flash 6 seconds Alarm: Remain lit Fault: Flash 2 seconds
Communication Wiring	
Wiring	Two-wire, polarity-free
Addressing Method	Electrical encoder
Address Range	1-254
Communication Distance	$\leq 1500\text{ m}$ (4921.26 ft)
Environment	
Operating Temperature	-10°C to $+50^{\circ}\text{C}$ ($+14^{\circ}\text{F}$ to $+122^{\circ}\text{F}$)
Storage Temperature	-20°C to $+65^{\circ}\text{C}$ (-4°F to $+149^{\circ}\text{F}$)
Operating Humidity	$\leq 95\%$ RH (no condensation)
Construction	
Color	White
Dimensions (with base)	$\Phi 100\text{ mm} \times 50\text{ mm}$ ($\Phi 3.00" \times 1.50"$)
Weight (with base)	102 g (0.22 lb)
Certification	GB 4715-2005

3 Device Installation

3.1 Packing List

Check the quantity and model. If you find device damage or any loss, contact the after-sales service.

3.2 Installation Steps

Prerequisites

- Determine the location, mounting distance and numbers for mounting the device in the protection area according to relevant provisions and regulations of the GB50166-2007 Code for Installation and Acceptance of Fire Alarm System, and connect the device correctly according to the construction drawing.
- Disconnect the power supply of the device before installation.
- Avoid places directly above the source of heat appliance.
- Use RVS twisted pairs with a section area of 1.5 mm^2 or 1.0 mm^2 for the signal buses.

Procedure

Step 1 Use two M4 screws to fix the device base on the embedded box or designated position, and make sure the matched mounting base has been firmly installed.

Figure 3-1 Installation (1)

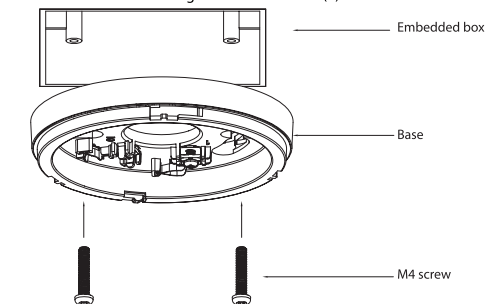

Step 2 Wiring the base. Connect terminals and fix on the base.



1, 2: Access terminal for the bus signal, polarity-free.

Figure 3-2 Mounting base

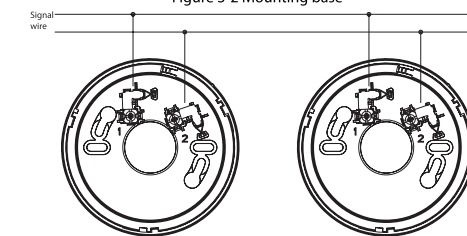
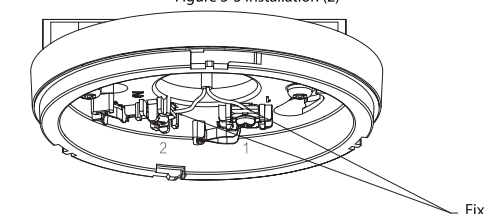

Figure 3-3 Installation (2)



Step 3 Code address.

- Use a coder to make the detector coded according to the detector address on the construction drawing.
- Press the number key to enter the address number, and then press "Confirmation" key to write the corresponding address to the device.
- After writing the address successfully, there will be a "DI" tone, and the address will be automatically increased by one.

Figure 3-4 Coding

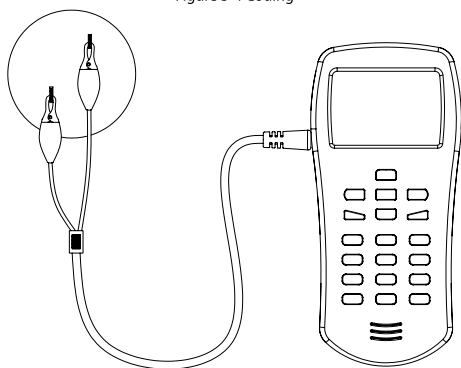

Step 4. Mount the device into the base by aligning them together and twisting the unit clockwise until it is firmly locked.

Figure 3-5 Installation (3)

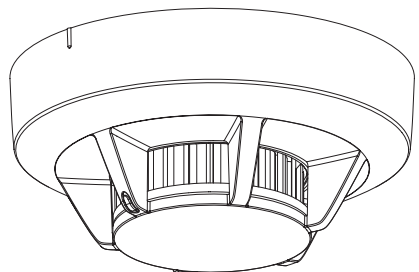
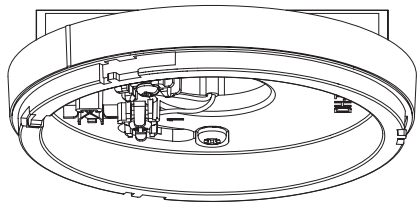
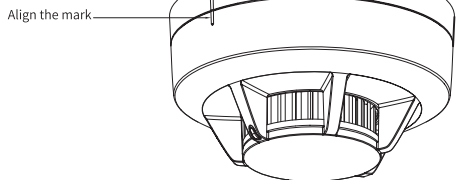

Figure 3-6 Installation (4)



Step 5. After all devices are installed and checked, connect the power supply of the Addressable Fire Alarm Control Panel and conduct automatic register.

4 FAQ

Problem	Solutions
The indicator light of the detector flashes quickly, and the screen of Fire Alarm Control Panel displays "Add or replace equipment"	While adding or replacing equipment, re-register in the System Debugging menu on the Fire Alarm Control Panel
The indicator light of the detector flashes quickly, and the screen of Fire Alarm Control Panel displays "LA repeated equipment information"	Contact technical support for advice and take off the wrong coding device, rewrite the code with the encoder, and re-register after installation
The indicator light of the detector does not light up, and the screen of Fire Alarm Control Panel displays "Registered device is offline"	Check whether the device is installed in place; if it is installed correctly, check the circuit, measure and ensure that the voltage of the equipment signal line is between 16V DC and 28V DC
The indicator light of the detector is constantly on, and Fire Alarm Control Panel reports a false fire alarm	Check whether there are interference sources such as steam and dust near the device
The indicator light of the detector flashes quickly, and the screen of Fire Alarm Control Panel displays "Failure"	Due to corrosion, drop, violent impact, etc., the sensor has a short circuit or open circuit failure, please contact the professionals

5 Test and Maintenance

5.1 Test

- After installation and register, test the detector by using a smoke blowing. When ambient smoke concentration reaches the alarm threshold, the indicator will turn to steady lighting and Fire Alarm Control Panel will simultaneously give alarm information.
- After completing the alarm test, reset the Fire Alarm Control Panel and restore to the normal operation.

5.2 Maintenance

To keep your device in good working condition, please follow these requirements.

- Simulate alarm test: Test the device once half a year (recommended).
- Before testing or maintaining, inform the proper authorities that the system is undergoing maintenance and will temporarily be put out of service.